

(EN) INSTRUCTION MANUAL  
 (DE) BEDIENUNGSANLEITUNG  
 (NL) GEBRUIKSAANWIJZING  
 (FR) MANUEL D'INSTRUCTIONS  
 (IT) MANUALE DI ISTRUZIONI

(ES) MANUAL DE INSTRUCCIONES  
 (FI) KÄYTTÖOPAS  
 (NO) BRUKSANVISNING  
 (SV) BRUKSANVISNING  
 (DA) BRUGSANVISNING





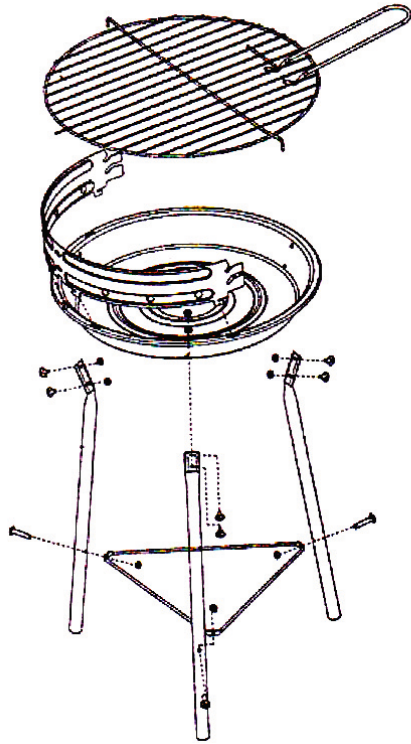

(HR) PRIRUČNIK S UPUTAMA  
 (PL) INSTRUKCJA OBSŁUGI  
 (EL) ΕΓΧΕΙΡΙΔΙΟ ΟΔΗΓΙΩΝ  
 (SR) UPUTSTVO ZA UPOTREBU

alпина®

ITEM NUMBER: 871125229107

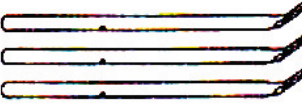
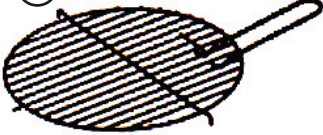
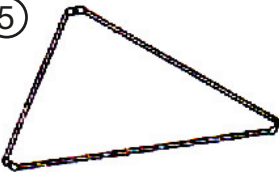





(EN) INSTRUCTION MANUAL

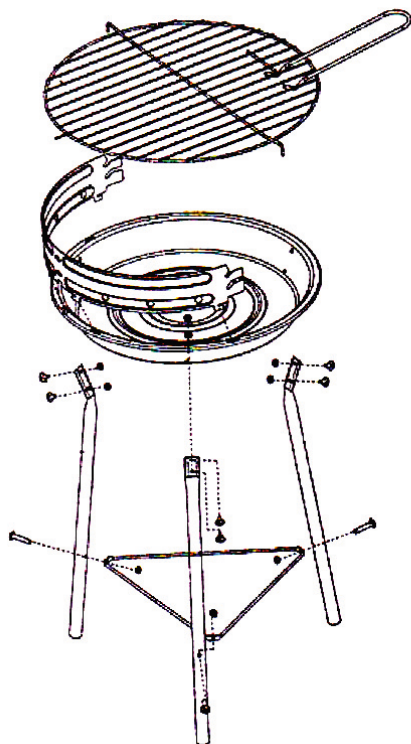

①  Scale charcoal	②  Windscreen
③  Legs	④  Grill grid
⑤  Legs fixation	⑥  9 nuts  6 bolts short  3 bolts large

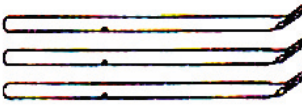
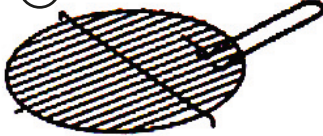
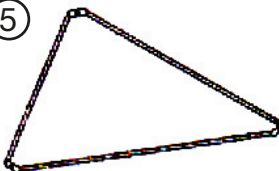
(DE) BEDIENUNGSANLEITUNG





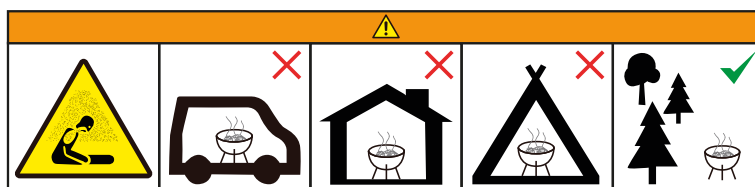

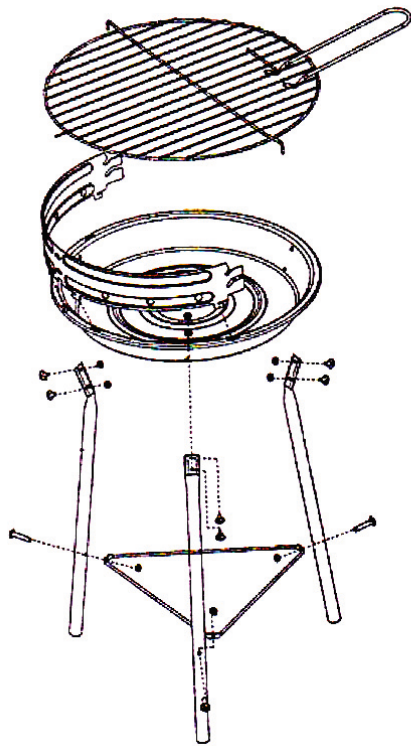

①  Kohle-Schale	②  Windschutz
③  Grillfüße	④  Grillgitter
⑤  Grillfußbefestigung	⑥  9 Muttern  6 Schrauben kurz  3 Schrauben lang

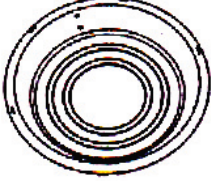

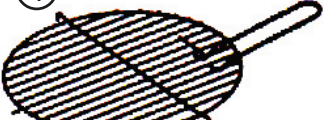
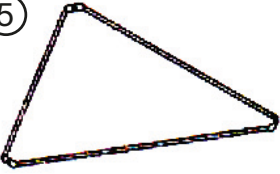





**(NL) GEBRUIKSAANWIJZING**

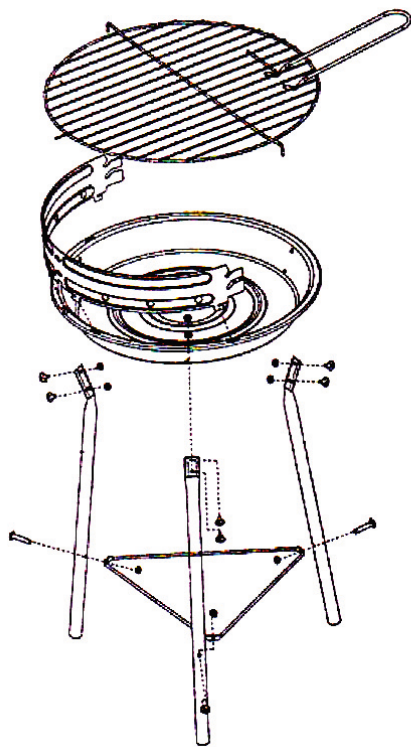

<p>①</p>  <p>Houtskoolhouder</p>	<p>②</p>  <p>Windscherm</p>
<p>③</p>  <p>Poten</p>	<p>④</p>  <p>Grillrooster</p>
<p>⑤</p>  <p>Pootbevestiging</p>	<p>⑥</p> <ul style="list-style-type: none"> <li> 9 moeren</li> <li> 6 bouten kort</li> <li> 3 bouten lang</li> </ul>

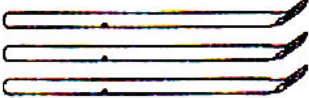
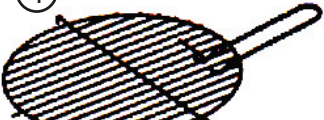
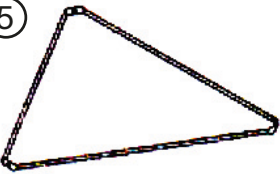
**(FR) MANUEL D'INSTRUCTIONS**





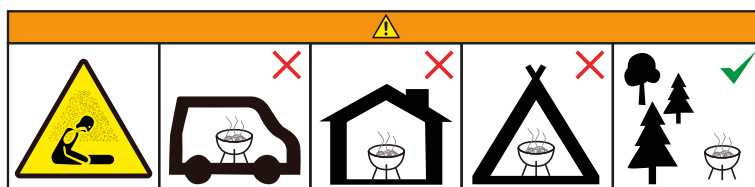

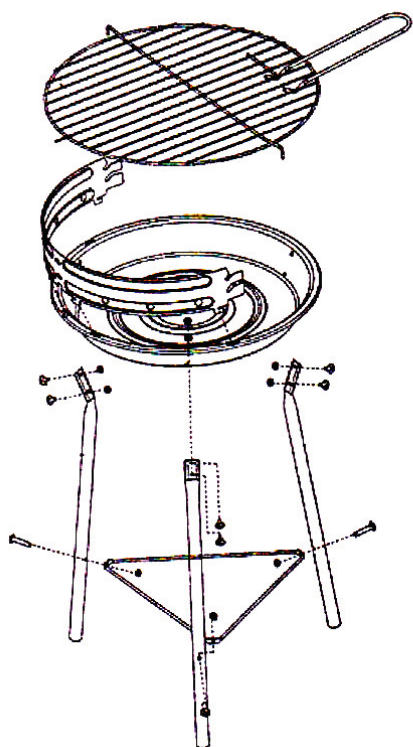

<p>①</p>  <p>Balance à charbon</p>	<p>②</p>  <p>Pare-vent</p>
<p>③</p>  <p>Pieds</p>	<p>④</p>  <p>Grille de cuisson</p>
<p>⑤</p>  <p>Fixation pour pieds</p>	<p>⑥</p> <ul style="list-style-type: none"> <li> 9 écrous</li> <li> 6 beulons courts</li> <li> 3 gros beulons</li> </ul>



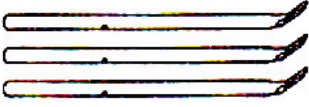
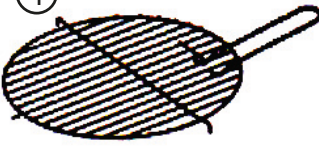





IT MANUALE DI ISTRUZIONI

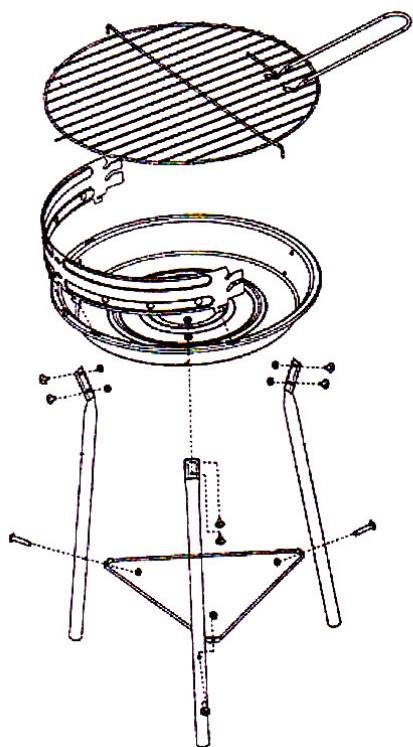

<p>①</p>  <p>Bilancia da carbone</p>	<p>②</p>  <p>Paravento</p>
<p>③</p>  <p>Gambe</p>	<p>④</p>  <p>Griglia</p>
<p>⑤</p>  <p>Dispositivo di fissaggio gambe</p>	<p>⑥</p> <ul style="list-style-type: none"> <li> 9 dadi</li> <li> 6 bulloni corti</li> <li> 3 bulloni grandi</li> </ul>

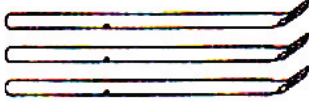
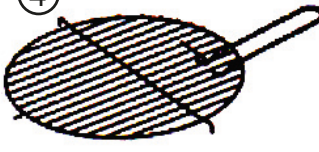
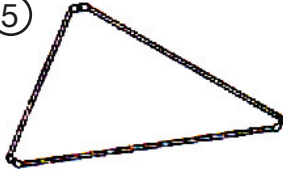
ES MANUAL DE INSTRUCCIONES



<p>①</p>  <p>Recipiente para carbón con escala</p>	<p>②</p>  <p>Paravientos</p>
<p>③</p>  <p>Patas</p>	<p>④</p>  <p>Parrilla</p>
<p>⑤</p>  <p>Sujeción para las patas</p>	<p>⑥</p> <ul style="list-style-type: none"> <li> 9 tuercas</li> <li> 6 pernos cortos</li> <li> 3 pernos largos</li> </ul>

